

3 valve positions only in conjunction with a second 3/2-way valve.
Corresponds to a 5/3-way valve.

Operating pressure: 2.5 to 10 bar (monostable)
1.0 to 10 bar (bistable)
Max. vacuum 10 bar (external pilot air)

Temperature range: -10 °C to +60 °C

Body and piston: Aluminium
Seal: NBR
Spring: Special steel

Flow rate at 6 bar and Δ 0.5 bar: 400 NI/min.
Flow rate at 6 bar and Δ 1.0 bar: 550 NI/min.



ASSEMBLY DIAGRAM FOR PILOT-ASSISTED HAND-OPERATED VALVES SERIES 70 WITH PANEL ACTUATORS

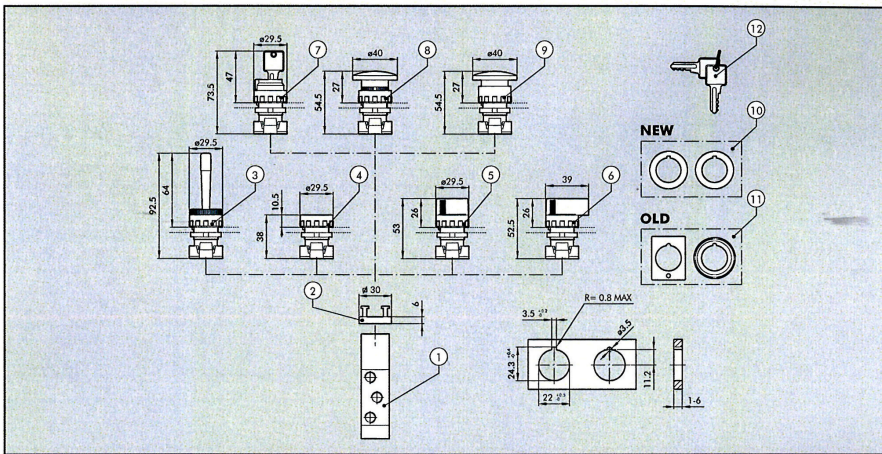

515.201



515.301



515.401



















515.501



515.601





ORDERING CODES

Symbol	Reference	Description	Code	Weight [g]
	①	Pilot-assisted plunger 3/2, 1/8"	515.201 to 515.701	124
	①	Pilot-assisted plunger 5/2, 1/8"	-	150
	②	2 places adaptor thickness 6.8 mm	-	5
	③	Red handler with horizontally pivoted lever	515.301	25
	④	Fat push button + 2 red/black coloured disks ◆ Bistable fat push button without disk	515.201	15
	⑤	Black selector short lever of 2 positions with return	515.401	20
	⑤	Black selector short lever of 2 positions Black selector short lever at 2 positions	515.402	20
	⑤	Black selector short lever of 3 positions with return	515.403	20
	⑤	Black selector short lever at 3 positions	515.404	20
	⑥	Black selector long lever at 2 positions with return	515.501	26
	⑥	Black selector long lever at 2 positions	515.502	26
	⑥	Black selector long lever at 3 positions with return	515.503	26
	⑥	Black selector long lever at 3 positions	515.504	26
	⑦	2 positions key selector with extractable key in 2 positions	-	50
	⑦	2 positions key selector with extractable key in 0	-	50
	⑧	Red mushroom-head push button ø40	515.601	27
	⑧	Black mushroom-head push button ø40	-	27
	⑨	Red mushroom-head push button with lock ø40	515.701	29
	⑩	◆ Reducer from 30 to 22.5 mm		
	⑪	▲ Adapter for bore ø30 G2326		
	⑫	◆ key for ESC selectors		
		Green disk for push button ④		

◆ It can't be supplied. As working replaced by selector with bistable short lever at 2 positions ⑤
◆ Usable only with technopolymer body selectors
▲ Usable only with metal body selectors

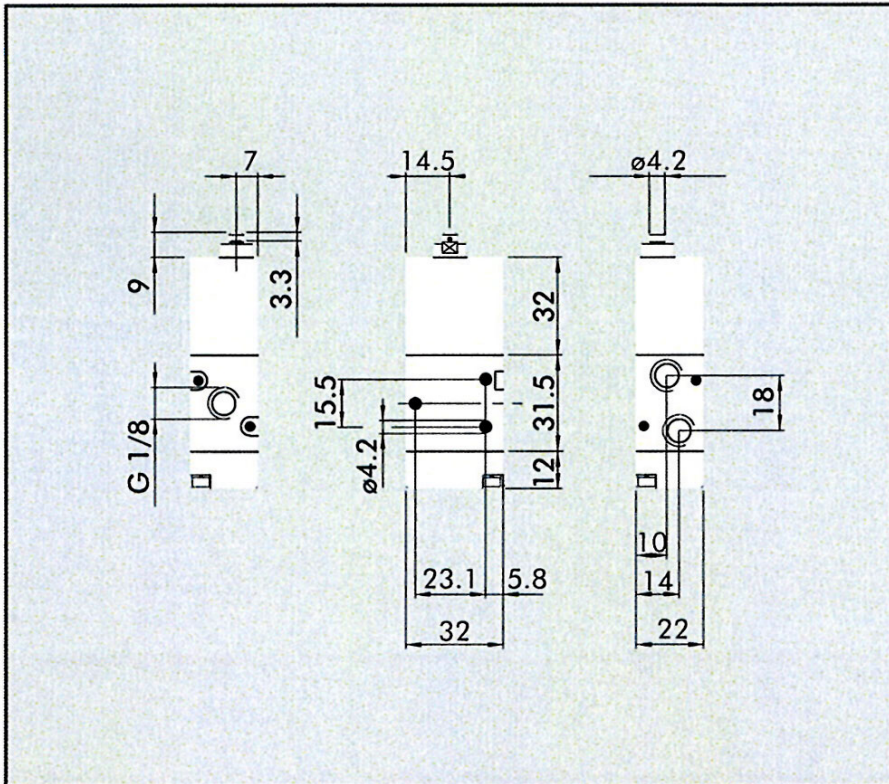
**PILOT-ASSISTED PLUNGER 3/2 1/8"
 FOR PANEL ACTUATORS**



Symbol	Abbrev.	Code	Weight [g]
	MAV 23 BRE NC	515.201 to 515.701	124

Type No.	Art. No.
515.201	106417
515.301	106418
515.401	106419
515.501	106423
515.601	106427
515.701	106428